

Ryterna TLP VL-MM Garage doors

Door parts list

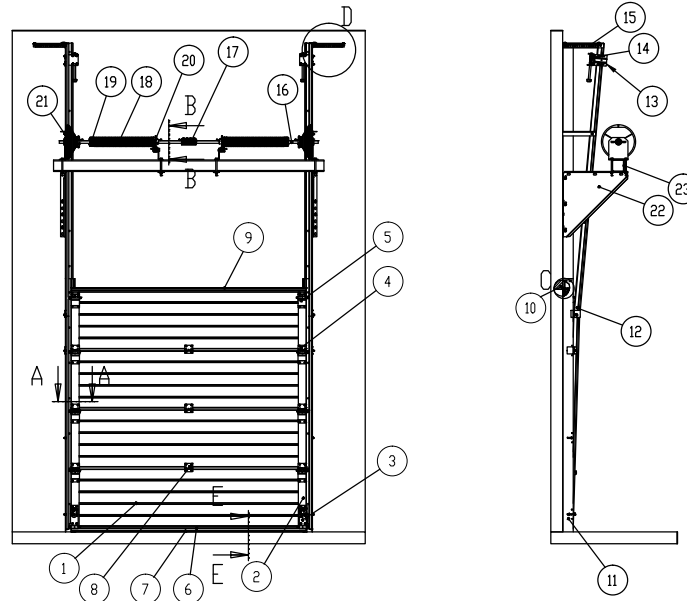

Nr.	Part
1	Sandwich panel
2	Panel endcap
3	Bottom roller bracket
4	Side roller bracket
5	Top roller bracket
6	Bottom profile
7	Bottom seal
8	Intermediate hinge
9	Top profile
10	Top seal
11	Vertical angle
12	Track
13	Corner for spring bumper
14	Spring bumper
15	Track fixing
16	Shaft
17	Aluminum coupler
18	Spring
19	Spring fitting
20	Spring break device
21	Drum
22	Triangular plate
23	Box beam

Door Cross-sections and detailed views

A-A(5:1)

Mounting types of vertical track profiles to a wall:

a) mounting to concrete or brick wall

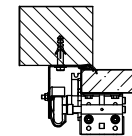

b) mounting to wood or steel tube

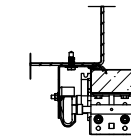

B-B(5:1)

Mounting types of spring bracket to a wall:

a) mounting to concrete or brick wall

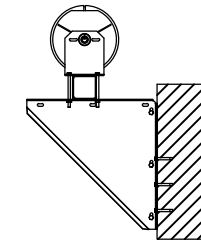

b) mounting to wood or steel tube

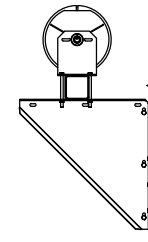

C(10:1)

Top seal place

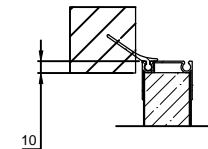

D(5:1)

Mounting types of horizontal tracks to a ceiling:

a) mounting to concrete

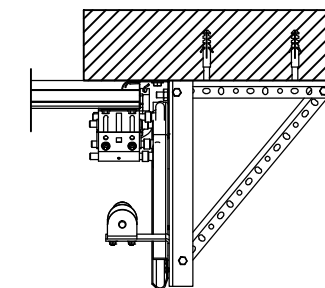

b) mounting to wood or steel tube

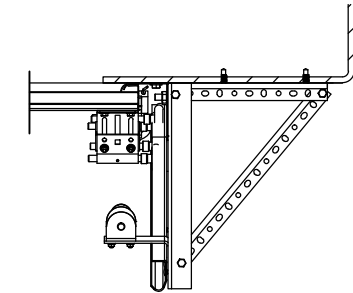

E(5:1)

Bottom seal and pass door step types:

a) No pass door

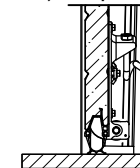

b) Standart step

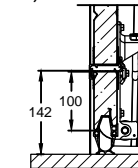

c) high step (for wide doors >6500)

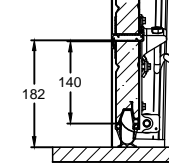

d) low doorstep

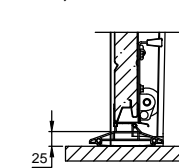

Space required for doors

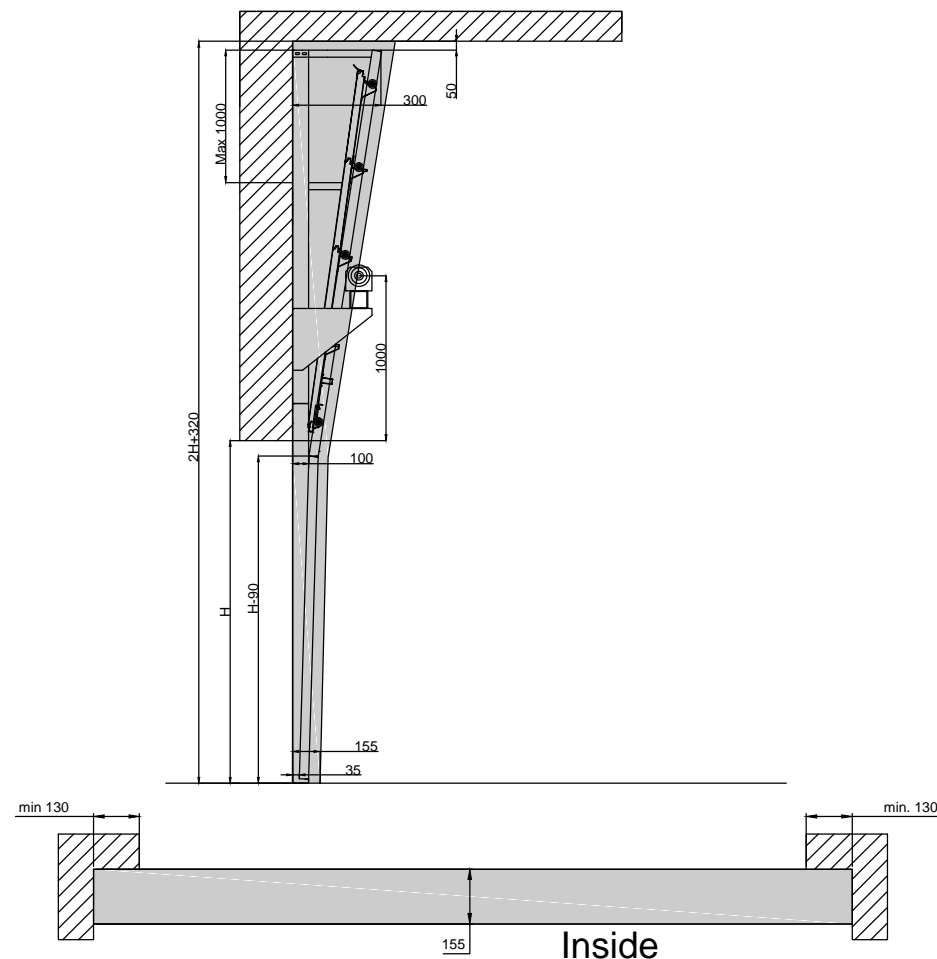

Ryterna Group

Tel.: +370 37 490990

www.Ryterna.eu

Drawn: Juozas Petrikas Date: 2016.06.30